

ASSEMBLY AND INSTALLATION

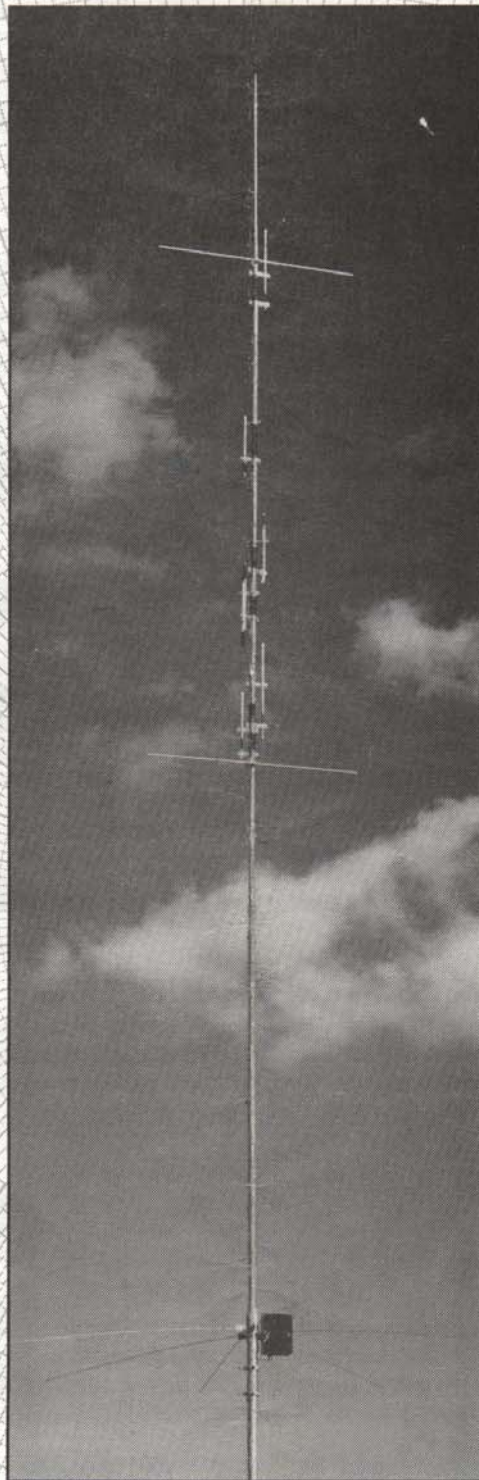

R7

10, 12, 15, 17, 20, 30, 40 METERS



951420 (7/93)

WARNING

THIS ANTENNA IS AN ELECTRICAL CONDUCTOR. CONTACT WITH POWER LINES CAN RESULT IN DEATH, OR SERIOUS INJURY. DO NOT INSTALL THIS ANTENNA WHERE THERE IS ANY POSSIBILITY OF CONTACT WITH OR HIGH VOLTAGE ARC-OVER FROM POWER CABLES OR SERVICE DROPS TO BUILDINGS. THE ANTENNA, SUPPORTING MAST AND/OR TOWER MUST NOT BE CLOSE TO ANY POWER LINES DURING INSTALLATION, REMOVAL OR IN THE EVENT PART OF THE SYSTEM SHOULD ACCIDENTALLY FALL. FOLLOW THE GUIDELINES FOR ANTENNA INSTALLATIONS RECOMMENDED BY THE U.S. CONSUMER PRODUCT SAFETY COMMISSION AND LISTED IN THE ENCLOSED PAMPHLET.

Your Cushcraft R7 vertical antenna is designed and manufactured to give trouble free service. This antenna will perform as specified if the instructions and suggestions in this manual are followed and care is used in the assembly and installation. When checking the components received in your antenna package use the parts listed beside each diagram. There is a master parts list on page 2. If you are unable to locate any tube or component, check the inside of all tubing. **IMPORTANT:** Save the weight label from the outside of the carton. Each antenna is weighed at the factory to verify the parts count. If you claim a missing part, you will be asked for the weight verification label.

PLANNING

Plan your installation carefully. If you use volunteer helpers be sure that they are qualified to assist you. Make certain that everyone involved understands that you are the boss and that they must follow your instructions. If you have any doubts at all, employ a professional antenna installation company to install your antenna.

LOCATION

Although the R7 will operate in almost any location, it will perform best if it is mounted vertically and located in the clear away from surrounding objects such as buildings, trees, power lines, towers, guy wires, antennas and metallic objects. The R7 should not be attached to a ground radial system. Failure to heed these points will possibly degrade performance, detune the antenna and increase VSWR.

EXTREME CARE MUST BE USED FOR YOUR SAFETY. YOU MUST INSURE THAT WHILE THE R7 IS IN OPERATION NEITHER PEOPLE OR PETS CAN COME IN CONTACT WITH ANY PORTION OF YOUR ANTENNA INCLUDING THE COUNTERPOISE RODS. DEADLY VOLTAGES AND CURRENTS MAY EXIST. ALSO, SINCE THE EFFECTS OF EXPOSURE TO RF ARE NOT FULLY UNDERSTOOD, LONG TERM EXPOSURE TO INTENSE RF FIELDS IS NOT RECOMMENDED. THERE ARE SEVEN WARNING STICKERS WHICH MUST BE ATTACHED TO THE ENDS OF THE COUNTERPOISE RODS AS SHOWN IN FIGURE 3.

MOUNTING

Your mast should be rigid and pointing straight up. Always use a mast at least 1.5 inches (3.8 cm) but not larger than 1.75 inches (4.5 cm) in diameter. If you guy the mast, use non-conducting guy wires.

SYSTEM GROUNDING

Direct grounding of the antenna mast is very important. This serves as protection from lightning strikes and static buildup, and from high voltages which may be present in the equipment attached to the antenna. A good electrical connection should be made to one or more ground rods directly at the base of the antenna or mast using a least #10 AWG ground wire and non-corrosive hardware. For details and safety standards, consult the National Electrical Code. You should also use a coaxial lightning arrestor. Cushcraft offers several different models, such as the LAC-1, LAC-2 or the LAC-4 series.

ASSEMBLY

Assemble your R7 by following steps 1 through 6. After assembling the antenna, verify all dimensions in figure 5 for accuracy. Then return to the adjustment section below for final tuning.

ADJUSTMENT

The dimensions in figure 5 normally allow proper operation on all the bands. However, some variations may occur from one location to another. Adjustments must be made from the bottom of the antenna to the top. Adjusting the antenna from top to bottom will not work. This is because the settings at the top are severely affected by the adjustments at the bottom. The bottom section A of the antenna covers 10 meters, the next sections cover 12, 15, 17, 20, and 30 meters while the top section F covers 40 meters.

We suggest measuring the VSWR of your antenna by using the SWR meter in your transceiver. If your transceiver does not have one, use a good quality VSWR bridge for this application. We will begin with 10 meters since this is at the bottom of the antenna. Set your transceiver at your favorite frequency on 10 meters. Key the rig and check your VSWR. The R7 is extremely broadbanded on 10 meters and this section seldom needs adjustment. If the VSWR is low enough (below 1.5:1) then move on to the 15 meter section B (12 meters is not adjustable). If the 10 meter VSWR is not low enough, adjust the antenna as follows: Check several frequencies on 10 meters to find the frequency of lowest VSWR. If the frequency of lowest VSWR is above your favorite frequency, lengthen dimension A (figure 5) by 1 inch (2.5 cm). This should lower the frequency of lowest VSWR by 50 to 100 KHz. If the frequency of lowest VSWR is below your desired frequency, shorten dimension A (figure 5) by 1 inch (2.5 cm). Check your desired 10 meter operating frequency again to see if the VSWR is less than 1.5:1. Repeat this procedure until the VSWR at your desired frequency is low enough.

Continue this procedure by selecting your desired frequency on 15 meters and checking the VSWR there. Dimension B (figure 5) should be used to adjust the VSWR on 15 meters. Remember to shorten this dimension to raise the frequency or lengthen it to lower the frequency.

The balance of the antenna should be adjusted in a like manner. The dimensions and the bands that they effect are shown in figure 5. On 10 through 20 meters 1 inch (2.5 cm) of change in length will change the operating frequency by 50 to 100 KHz. On 30 and 40 meters the change will

be 15 to 25 KHz per inch (5 to 10 KHz/cm). When the antenna is completely adjusted, check all fasteners to be sure they are tight. Improving VSWR's that are less than 2:1 will not noticeably improve station performance.

INSTALLATION

Following the guidelines in the location and adjustment sections above, place the antenna on its mast in its final operating location. If you plan to install the antenna in a salty or corrosive environment, you may want to consider coating it with a clear marine varnish or equivalent *after final assembly and adjustment has been completed*. Now connect your transceiver. If you have any difficulties, reread the information above and the helpful hints below.

HELPFUL HINTS

- Try to locate your R7 as far away from TV antennas and their feedlines as possible. This will help to avoid overloading your television with RF.
- The dimensions recommended in figure 5 are based on mounting the R7 approximately 8 feet (2.4 meters) above the ground and 25 feet (7.5 meters) from surrounding objects. Antennas installed with less clearance may require additional adjustments.
- If you check the resistance across the coax connector on your R7 you will find a DC short. This is normal. It does not mean that the RF path is short circuited. It is approximately 50 Ohms at your operating frequencies.
- High VSWR is sometimes caused by poor contact between the matching network and the counterpoise rods. Make sure that corrosion has not formed on the jumper strap terminals. Check to insure the hardware is tight.
- Make sure that the counterpoise brackets are 1 inch (2.54 cm) above the antenna base and 1-3/4 inch (4.45 cm) below the radiator as shown on figure 1. The counterpoise is a frequency sensitive system. Changing its length will degrade the R7's performance.
- If your R7 is very close to your shack you may experience RF on the feedline. Try lengthening your feedline several feet, placing an RF ferrite bead on the coax, winding the feedline on a toroid or winding the coax in a 10 turn coil 8 inches (20 cm) in diameter.
- Weather sealing the matching network is not necessary. We have provided a large hole near the coax connector to allow air to circulate through the box and to keep it dry. Keep this hole clear to avoid difficulties caused by humidity and condensation.
- Long periods (30 seconds or longer) of key down operation, such as RTTY, at high power (over 1000 Watts) may damage your R7.

MASTER PARTS LIST

KEY	P/N	DESCRIPTION	QTY	KEY	P/N	DESCRIPTION	QTY
AA		Base Section Assembly, 1-3/8" x 48" (2.8 x 121.9 cm)	1	41	011941	#8 split lock washer	28
AB		1-1/4" x 48" (3.2 x 121.9 cm) aluminum tube slotted one end	1	77	050077	3/8" (.95 cm) black plastic cap	1
AC		1-1/8" x 48" (2.9 x 121.9 cm) aluminum tube slotted one end	1	79	010079	8-32 x 1/2" (1.27 cm) stainless steel machine screw	21
AD		1-1/8" x 9" (2.9 x 22.9 cm) aluminum tube slotted both ends	1	83	010083	1/4-20 x 1-1/4" (3.2 cm) stainless steel machine screw	4
AE		1" x 14" (2.5 x 35.6 cm) aluminum tube slotted both ends	2	84	010084	1/4" (.63 cm) stainless steel split lock washer	4
AG		1/2" x 24" (1.3 x 61 cm) aluminum tube slotted one end	1	85	010085	1/4-20 stainless steel hex nut	4
AH		3/8" x 24" (.9 x 61 cm) aluminum tube	1	96	202296	7/8" x 3-3/4" (2.22 x 9.53 cm) radial clamp	6
TV1		10/12 meter trap assembly 34-5/8" (88 cm)	1	110	203110	Mast mounting ring	2
TV2		15 meter trap assembly 15" (38.1 cm)	1	115	050115	Vinyl connector boot	1
TV3		17 meter trap assembly 15-3/4" (40 cm)	1	116	240116	Silicone grease packet	1
TV4		20 meter trap assembly 21" (53.3 cm)	1	119	203119	7/8" x 5-3/8" (2.22 x 13.7 cm) radial clamp	1
TV5		30 meter trap assembly 23" (58.4 cm)	1	220	010220	10-24 stainless steel hex nut	1
XHR		3/16" x 36" (.4 x 91.4 cm) aluminum rod with #18 hole drilled mid point	4	231	010231	8-32 x 1-3/4" (4.44 cm) stainless steel machine screw	4
MN7		Impedance Matching Assembly	1	233	010233	#10 stainless steel split lock washer	1
11	010011	8-32 stainless steel hex nut	28	407	030407	7/32" (.5 cm) stainless steel worm clamp	1
26	190026	7/8" (2.22 cm) formed aluminum bracket with #8 hole	4	409	030409	7/8" (2.22 cm) stainless steel worm clamp	1
28	190028	Aluminum half washer	4	410	030410	1" (2.54 cm) stainless steel worm clamp	5
				411	030411	1-1/4" (3.17 cm) stainless steel worm clamp	3
				412	030412	1-1/2" (3.81 cm) stainless steel worm clamp	2
				326	290326	Warning label	7
				428	902428	Jumper Strap	2
				832	902832	0.100" x 49" (.25 x 124 cm) stainless steel rod with ball tip one end	7

#1 - ASSEMBLE COUNTERPOISE BRACKETS

- ✓ Assemble two brackets (96) leaving the nuts (11) loose (figure 1). Make three sets like this. Attach two sets together around the base insulator making the lower bracket assembly. Locate the lower bracket assembly 1 inch (2.54 cm) above the base tube (figure 2). Attach the two remaining brackets (96) you previously assembled around the base insulator using bracket (119) as shown in figure 2. Locate this upper bracket assembly directly above and touching the lower bracket assembly.





KEY	PN		DESC.	SIZE	QTY
11	010011		HEX NUT	8-32	21
41	011941		LOCK WASHER	#8	21
79	010079		MACHINE SCREW	8-32 x 1/2" (1.3 cm)	21
96	202296		ROD BRACKET	3-3/4" x 7/8" (9.53 x 2.22 cm)	6
119	203119		ROD BRACKET	5-3/8" x 7/8" (13.7 x 2.22 cm)	1

FIGURE 1

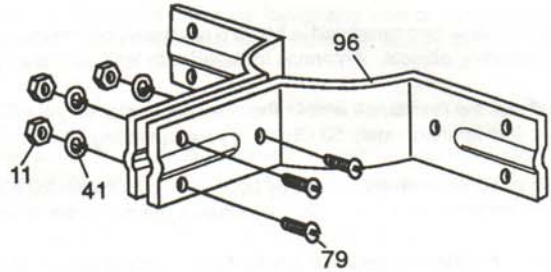
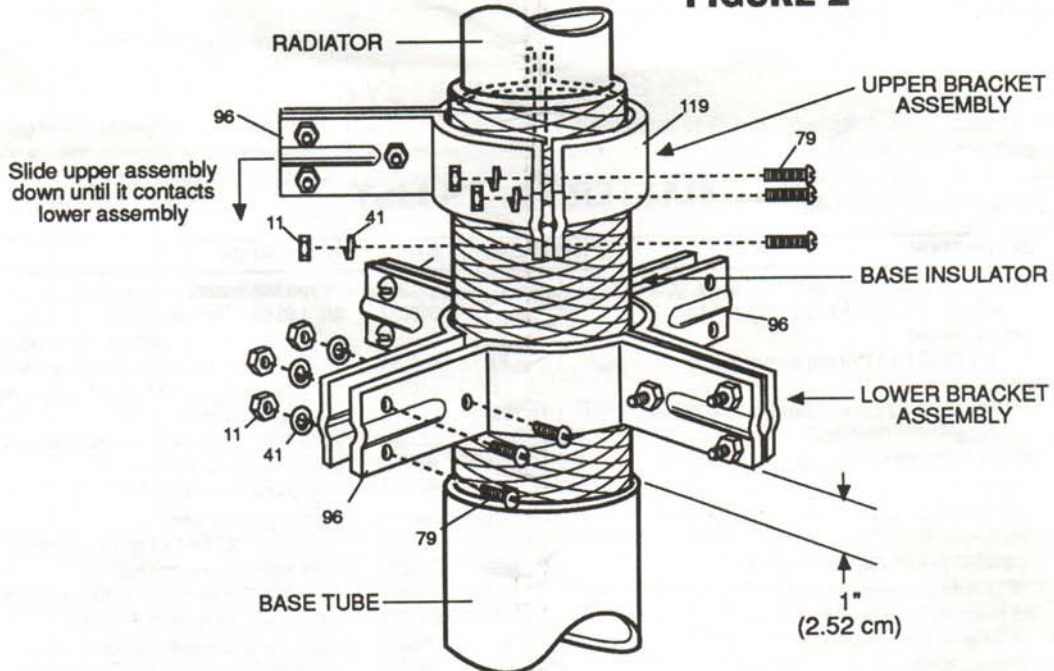

FIGURE 2



#2 - ASSEMBLE BASE SECTION

FIGURE 3

Attach the Impedance Matching Assembly (MN7) to the radiator bracket (figure 3). To do this you may have to rotate the counterpoise bracket assemblies (figure 2) slightly if they are in the way. Note that the half round bracket (119) in the upper assembly must be directly behind the MN7. Holding the box with the pre-attached bracket on the bottom and next to the base tube, lift the box so that the mounting bolts on the top of the box go through the holes in the

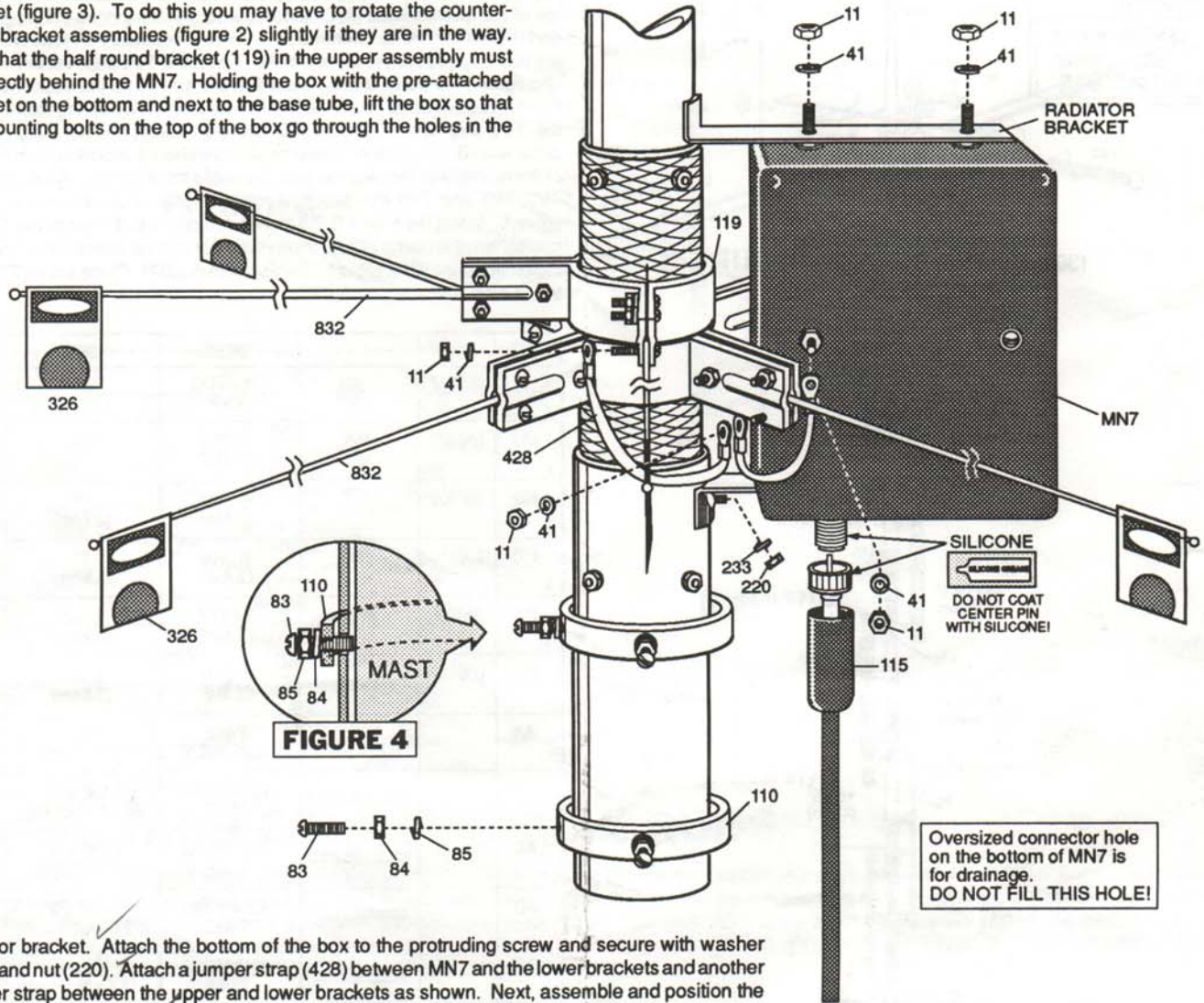

FIGURE 4

radiator bracket. Attach the bottom of the box to the protruding screw and secure with washer (233) and nut (220). Attach a jumper strap (428) between MN7 and the lower brackets and another jumper strap between the upper and lower brackets as shown. Next, assemble and position the mast mount rings (110). Be sure that the locking screws in the mast mount ring go through the pre-drilled holes in the R7 base (figure 4). The counterpoise rods will be attached later (step 5).

KEY	PN	DESC.	SIZE	QTY
11	010011	HEX NUT	8-32	3
41	011941	LOCK WASHER	#8	3
83	010083	MACHINE SCREW	1/4-20 x 1-1/4" (3.2 cm)	4
84	010084	LOCK WASHER	1/4" (.6 cm)	4
85	010085	HEX NUT	1/4-20	4
110	203110	MAST MT. RING		2
115	050115	CONNECTOR BOOT		1

KEY	PN	DESC.	SIZE	QTY
116	240116	SILICONE PACKET		1
220	010220	HEX NUT	10-24	1
233	010233	LOCK WASHER	#10	1
326	290326	WARNING LABEL		7
428	902428	JUMPER STRAP		2
832	902832	COUNTERPOISE ROD	49" (124 cm)	7
MN7		IMPEDANCE MATCHING ASSEMBLY		1

#3 - ASSEMBLE VERTICAL

When the base assembly is completed, place worm clamp (412) over the top of the radiator tube (AA). Insert the tube AB 6 inches (15 cm) into AA and tighten the clamp. Continue the same procedure with tube AC. Place worm clamp (411) over the top of AC, insert the TV1 trap, set dimension A and tighten the worm clamp. Note that the arrows on the traps must point up when assembled. (The X-hats will be attached later during step 4.) Attach the TV2 trap with the tube AD centered between the traps and set dimension B. The external trap capacitors should alternate from one side of the antenna to the other as you assemble the antenna. Assemble traps TV3, TV4 and TV5 with tubes, worm clamps and dimensions shown on figure 5. Insert the tube AG 7.5 inches (19 cm) into the top of the TV5 trap and tighten the clamp (409). Insert tube AH and set dimension F using the dimensions shown in table 1. Tighten clamp (407). Place a cap (77) on the top of tube AH.

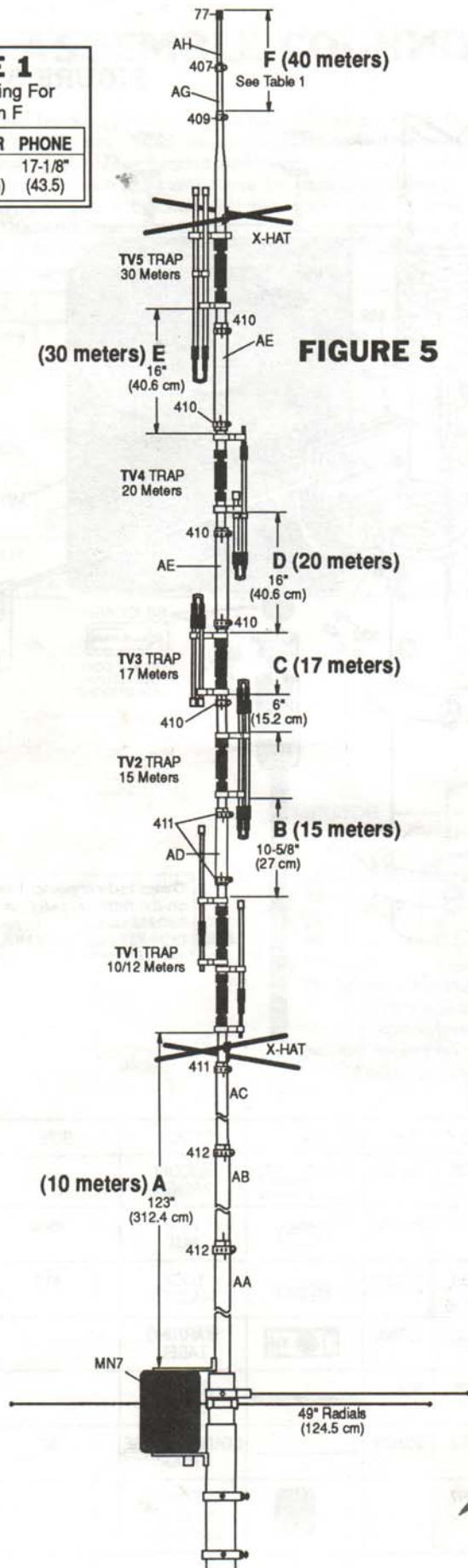





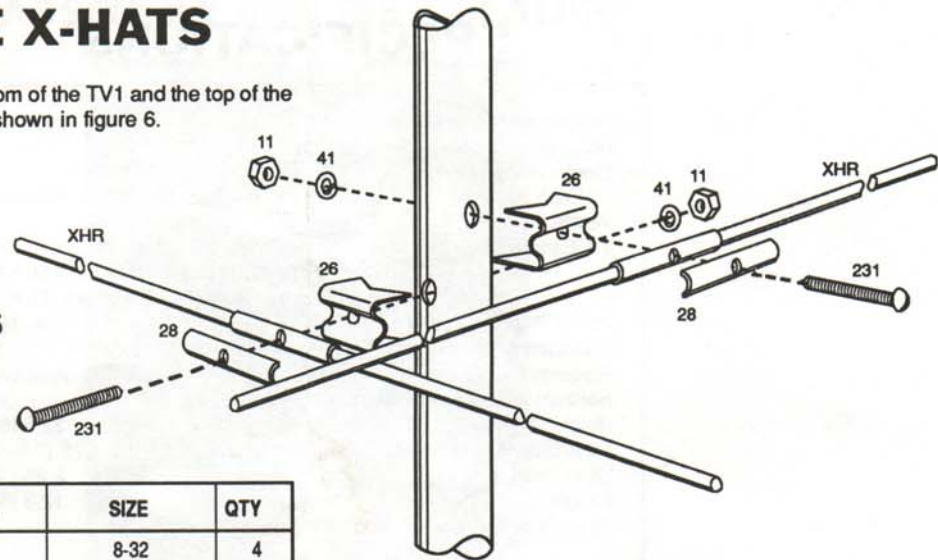

KEY	PN		DESC.	SIZE	QTY
77	050077		PLASTIC CAP	3/8" (.95 cm)	1
407	030407		WORM CLAMP	7/32" (.5 cm)	1
409	030409		WORM CLAMP	7/8" (2.2 cm)	1
410	030410		WORM CLAMP	1" (2.5 cm)	5
411	030411		WORM CLAMP	1-1/4" (3.2 cm)	3
412	030412		WORM CLAMP	1-1/2" (3.8 cm)	2
AA			BASE ASSEMBLY	48" (121.9 cm)	1
AB			ALUMINUM TUBE	1-1/4" x 48" (3.2 X 121.9 cm)	1
AC			ALUMINUM TUBE	1-1/8" x 48" (2.9 x 121.9 cm)	1
AD			ALUMINUM TUBE	1-1/8" x 9" (2.9 X 22.9 cm)	1
AE			ALUMINUM TUBE	1" x 14" (2.5 x 35.6 cm)	2
AG			ALUMINUM TUBE	1/2" x 24" (1.3 x 61 cm)	1
AH			ALUMINUM TUBE	3/8" x 24" (.9 x 61 cm)	1
TV1			10/12 METER TRAP	34-5/8" (88 cm)	1
TV2			15 METER TRAP	15" (38.1 cm)	1
TV3			17 METER TRAP	15-3/4" (40 cm)	1
TV4			20 METER TRAP	21" (53.3 cm)	1
TV5			30 METER TRAP	22-1/4" (56.5 cm)	1

#4 - ASSEMBLE X-HATS

Assemble and attach the X-hats to the bottom of the TV1 and the top of the TV5 traps (using the pre-drilled holes) as shown in figure 6.

FIGURE 6



KEY	PN		DESC.	SIZE	QTY
11	010011		HEX NUT	8-32	4
26	190026		FORMED BRACKET	7/8" (2.2 cm)	4
28	190028		ALUM. HALF WASHER		4
41	011941		LOCK WASHER	#8	4
231	010231		MACHINE SCREW	8-32x1-3/4" (4.4 cm)	4
XHR			X-HAT ROD	36" (91.4 cm)	4

#5 - ATTACH COUNTERPOISE RODS

Insert four of the 49 inch (124 cm) counterpoise rods into the slots on the end of the lower bracket assembly on the base insulator. Adjust the brackets so that the rods are equally spaced about the matching network. Firmly tighten the machine screws and nuts while observing the location of the brackets on the base insulator (figure 2). Insert the remaining three counterpoise rods into the ends of the upper bracket assembly. Tighten the machine screws. Attach the warning labels (326) to the ends of the counterpoise rods as shown in figure 3. **IT IS VERY IMPORTANT TO USE THE WARNING LABELS BECAUSE DEADLY VOLTAGES CAN BE PRESENT ON THESE RODS.**

#6 - FEEDLINE

We have provided a weatherproof boot for the PL-259 connector on your feedline. Follow figure 3 to install it. Insert the antenna end of your coax through the small end of your connector boot. Many cables are very tight which results in an excellent weather seal. Attach a PL-259 to the end of your coax. Spread the silicone on the threads of the antenna connector. **SILICONE SHOULD NOT BE SPREAD ON THE CENTER PIN!** Apply the remaining silicone to the outside of the connector. Attach the connector to the matching network and slip the boot over the connector until it touches the bracket. Return to the adjustment section on page 1.

SPECIFICATIONS

Frequency Bands (Meters)	10, 12, 15, 17, 20, 30, 40
Gain, dBi	3
Electrical Wavelength	
Each band	Half-wave
VSWR 1.2:1 Typical	
2:1 Bandwidth	10m (2.0 MHz), 12m (100 KHz) 15m (450 KHz), 17m (100 KHz), 20m (150 KHz) 30m (50 KHz), 40m (75 KHz)
Power Rating, Watts PEP	1800
Radiation Angle Typical	16°
Frequency Selection	Automatic
Horizontal Radiation Pattern, Degrees	360°
Height, ft. (m)	22.5 (6.9)
Mast Size Range, in. (cm)	1.5-1.75 (3.8-4.4)
Wind Load, ft. ² (m ²)	2.25 (.21)
Weight, lb. (kg)	12.3 (5.6)
49 in. (124 cm) Counterpoise Radials	7

TYPICAL R7 VSWR DATA

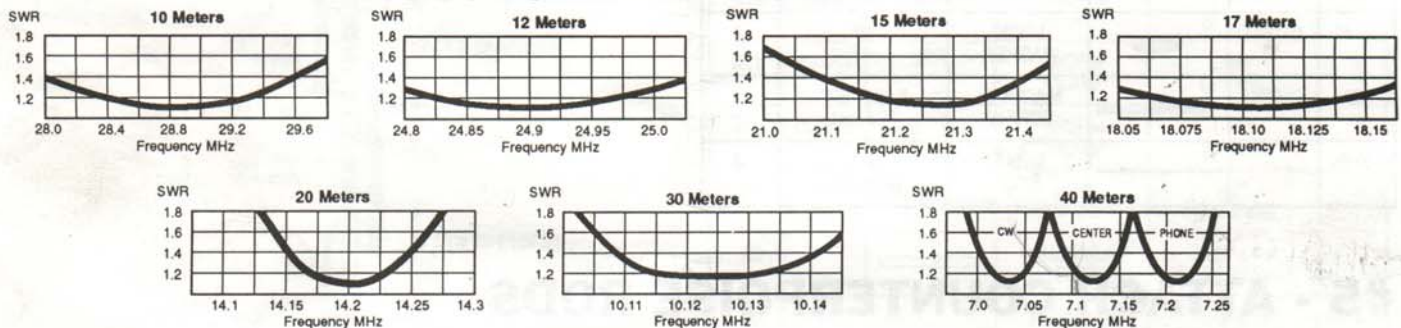

LIMITED WARRANTY

Cushcraft Corporation, P.O. Box 4680, Manchester, New Hampshire 03108, warrants to the original consumer purchaser for one year from date of purchase that each Cushcraft antenna is free of defects in material or workmanship. If, in the judgement of Cushcraft, any such antenna is defective, then Cushcraft Corporation will, at its option, repair or replace the antenna at its expense within thirty days of the date the antenna is returned (at purchaser's expense) to Cushcraft or one of its authorized representatives. This warranty is in lieu of all other expressed warranties, any implied warranty is limited in duration to one year. Cushcraft Corporation shall not be liable for any incidental or consequential damages which may result from a defect. Some states do not allow limitations on how long an implied warranty lasts or exclusions or limitations of incidental or consequential damages, so the above limitation and exclusion may not apply to you. This warranty gives you specific legal rights, and you may also have other rights which vary from state to state. This warranty does not extend to any products which have been subject to misuse, neglect, accident or improper installation. Any repairs or alterations outside of the Cushcraft factory will nullify this warranty.



WHERE PERFORMANCE IS A TRADITION

48 PERIMETER ROAD, MANCHESTER, NH, 03108 USA
TELEPHONE: 603-627-7877 • FAX: 603-627-1764 • TELEX: 4949472